

**OptiMOS<sup>®</sup> 2 Power-Transistor**
**Package**
**Marking**

- Qualified according to JEDEC<sup>1)</sup> for target applications
- N-channel, logic level
- Excellent gate charge x  $R_{DS(on)}$  product (FOM)
- Superior thermal resistance
- 175 °C operating temperature
- Pb-free lead plating; RoHS compliant

**Product Summary**

$V_{DS}$	30	V
$R_{DS(on),max}$	4.8	m $\Omega$
$I_D$	90	A

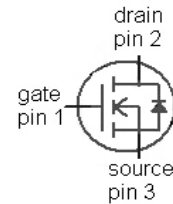

Type	IPD05N03LB G	IPS05N03LB G
<b>Package</b>	PG-TO252-3-11	PG-TO251-3-11
<b>Marking</b>	05N03LB	05N03LB

**Maximum ratings, at  $T_j=25\text{ °C}$ , unless otherwise specified**

Parameter	Symbol	Conditions	Value	Unit
Continuous drain current	$I_D$	$T_C=25\text{ °C}^{2)}$	90	A
		$T_C=100\text{ °C}$	74	
Pulsed drain current	$I_{D,pulse}$	$T_C=25\text{ °C}^{3)}$	420	
Avalanche energy, single pulse	$E_{AS}$	$I_D=90\text{ A}$ , $R_{GS}=25\ \Omega$	120	mJ
Reverse diode $dv/dt$	$dv/dt$	$I_D=90\text{ A}$ , $V_{DS}=20\text{ V}$ , $di/dt=200\text{ A}/\mu\text{s}$ , $T_{j,max}=175\text{ °C}$	6	kV/ $\mu\text{s}$
Gate source voltage <sup>4)</sup>	$V_{GS}$		$\pm 20$	V
Power dissipation	$P_{tot}$	$T_C=25\text{ °C}$	94	W
Operating and storage temperature	$T_j$ , $T_{stg}$		-55 ... 175	°C
IEC climatic category; DIN IEC 68-1			55/175/56	

Parameter	Symbol	Conditions	Values			Unit
			min.	typ.	max.	

**Thermal characteristics**

Thermal resistance, junction - case	$R_{thJC}$		-	-	1.6	K/W
SMD version, device on PCB	$R_{thJA}$	minimal footprint	-	-	75	
		6 cm <sup>2</sup> cooling area <sup>5)</sup>	-	-	50	

**Electrical characteristics, at  $T_j=25\text{ °C}$ , unless otherwise specified**
**Static characteristics**

Drain-source breakdown voltage	$V_{(BR)DSS}$	$V_{GS}=0\text{ V}, I_D=1\text{ mA}$	30	-	-	V
Gate threshold voltage	$V_{GS(th)}$	$V_{DS}=V_{GS}, I_D=40\text{ }\mu\text{A}$	1.2	1.6	2	
Zero gate voltage drain current	$I_{DSS}$	$V_{DS}=30\text{ V}, V_{GS}=0\text{ V}, T_j=25\text{ °C}$	-	0.1	1	$\mu\text{A}$
		$V_{DS}=30\text{ V}, V_{GS}=0\text{ V}, T_j=125\text{ °C}$	-	10	100	
Gate-source leakage current	$I_{GSS}$	$V_{GS}=20\text{ V}, V_{DS}=0\text{ V}$	-	10	100	nA
Drain-source on-state resistance	$R_{DS(on)}$	$V_{GS}=4.5\text{ V}, I_D=50\text{ A}$	-	6.0	7.7	m $\Omega$
		$V_{GS}=4.5\text{ V}, I_D=50\text{ A},$ SMD version	-	5.8	7.5	
		$V_{GS}=10\text{ V}, I_D=60\text{ A}$	-	4.1	5.0	
		$V_{GS}=10\text{ V}, I_D=60\text{ A},$ SMD version	-	3.9	4.8	
Gate resistance	$R_G$		-	1	-	$\Omega$
Transconductance	$g_{fs}$	$ V_{DS} >2 I_D R_{DS(on)max},$ $I_D=60\text{ A}$	48	96	-	S

<sup>1)</sup> J-STD20 and JESD22

<sup>1)</sup> Current is limited by bondwire; with an  $R_{thJC}=1.6\text{ K/W}$  the chip is able to carry 104 A.

<sup>3)</sup> See figure 3

<sup>4)</sup>  $T_{j,max}=150\text{ °C}$  and duty cycle  $D<0.25$  for  $V_{GS}<-5\text{ V}$ 
<sup>5)</sup> Device on 40 mm x 40 mm x 1.5 mm epoxy PCB FR4 with 6 cm<sup>2</sup> (one layer, 70  $\mu\text{m}$  thick) copper area for drain connection. PCB is vertical in still air.

Parameter	Symbol	Conditions	Values			Unit
			min.	typ.	max.	

**Dynamic characteristics**

Input capacitance	$C_{iss}$	$V_{GS}=0\text{ V}, V_{DS}=15\text{ V},$ $f=1\text{ MHz}$	-	2400	3200	pF
Output capacitance	$C_{oss}$		-	860	1100	
Reverse transfer capacitance	$C_{rss}$		-	110	160	
	$t_{d(on)}$	$V_{DD}=15\text{ V}, V_{GS}=10\text{ V},$ $I_D=45\text{ A}, R_G=2.7\ \Omega$	-	9	14	ns
Rise time	$t_r$		-	7	10	
Turn-off delay time	$t_{d(off)}$		-	28	42	
Fall time	$t_f$		-	4.6	7	

**Gate Charge Characteristics<sup>6)</sup>**

Gate to source charge	$Q_{gs}$	$V_{DD}=15\text{ V}, I_D=45\text{ A},$ $V_{GS}=0\text{ to }5\text{ V}$	-	8	11	nC
Gate charge at threshold	$Q_{g(th)}$		-	3.9	5.1	
Gate to drain charge	$Q_{gd}$		-	5.1	8	
Switching charge	$Q_{sw}$		-	9	13	
Gate charge total	$Q_g$		-	19	25	
Gate plateau voltage	$V_{plateau}$		-	3.3	-	
Gate charge total, sync. FET	$Q_{g(sync)}$	$V_{DS}=0.1\text{ V},$ $V_{GS}=0\text{ to }5\text{ V}$	-	16	22	nC
Output charge	$Q_{oss}$	$V_{DD}=15\text{ V}, V_{GS}=0\text{ V}$	-	19	26	

**Reverse Diode**

Diode continuous forward current	$I_S$	$T_C=25\text{ }^\circ\text{C}$	-	-	78	A
Diode pulse current	$I_{S,pulse}$		-	-	420	
Diode forward voltage	$V_{SD}$	$V_{GS}=0\text{ V}, I_F=78.125\text{ A},$ $T_J=25\text{ }^\circ\text{C}$	-	0.93	1.2	V
Reverse recovery charge	$Q_{rr}$	$V_R=15\text{ V}, I_F=I_S,$ $di_F/dt=400\text{ A}/\mu\text{s}$	-	-	15	nC

<sup>6)</sup> See figure 16 for gate charge parameter definition

**1 Power dissipation**

$$P_{tot} = f(T_C)$$

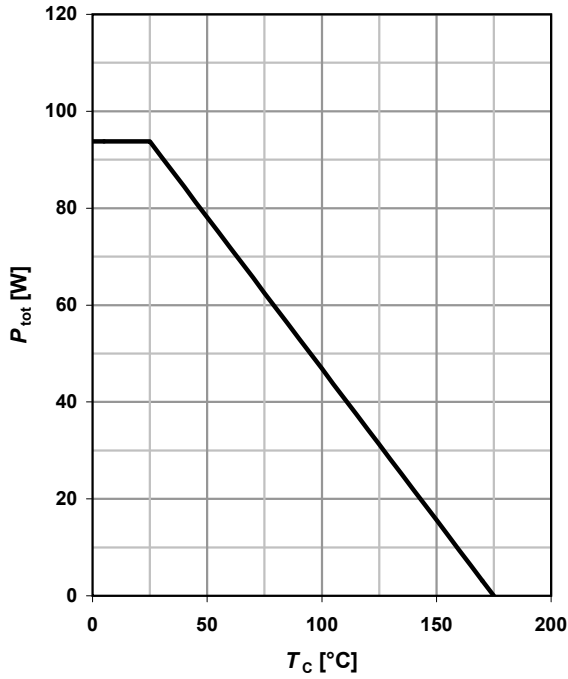

**2 Drain current**

$$I_D = f(T_C); V_{GS} \geq 10 \text{ V}$$

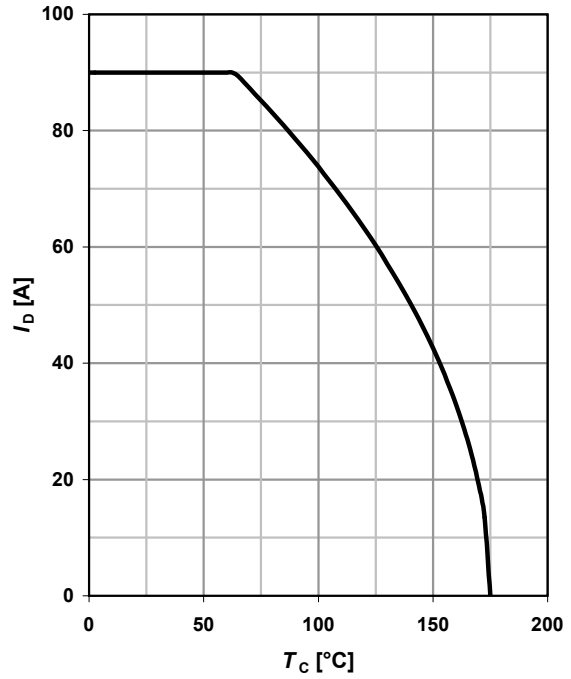

**3 Safe operating area**

$$I_D = f(V_{DS}); T_C = 25 \text{ °C}; D = 0$$

parameter:  $t_p$

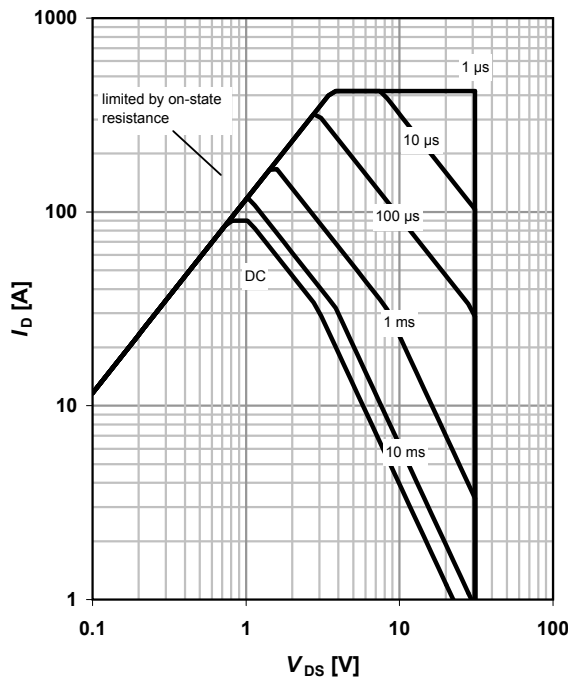

**4 Max. transient thermal impedance**

$$Z_{thJC} = f(t_p)$$

parameter:  $D = t_p / T$

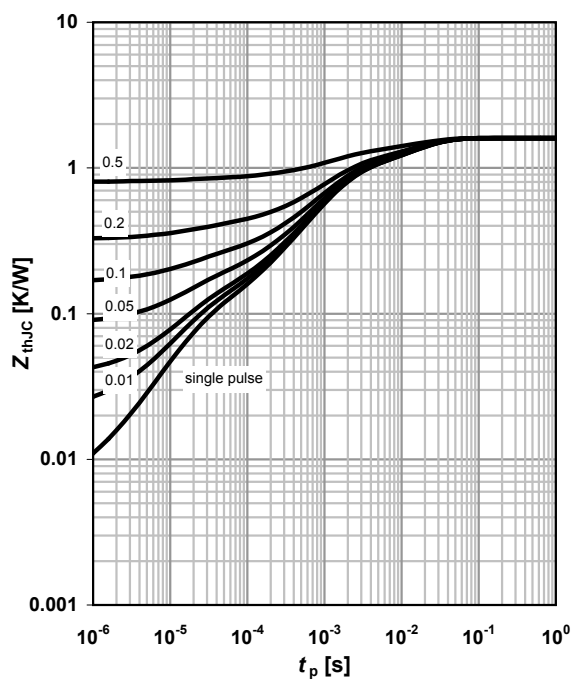

**5 Typ. output characteristics**

$I_D = f(V_{DS}); T_j = 25\text{ }^\circ\text{C}$

parameter:  $V_{GS}$

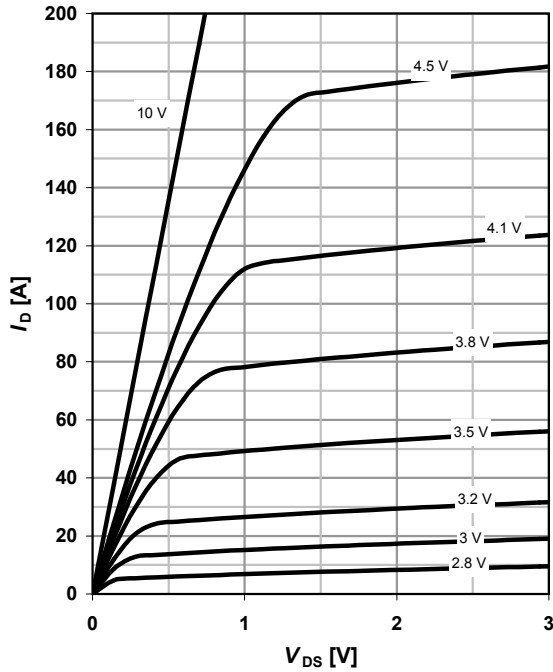

**6 Typ. drain-source on resistance**

$R_{DS(on)} = f(I_D); T_j = 25\text{ }^\circ\text{C}$

parameter:  $V_{GS}$

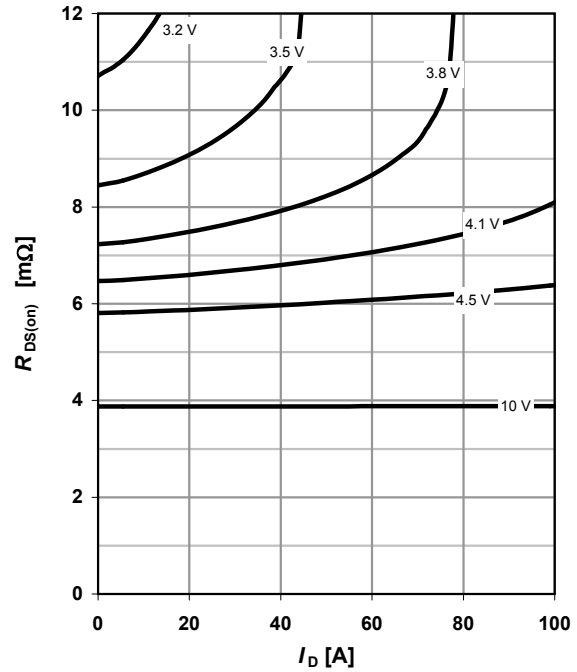

**7 Typ. transfer characteristics**

$I_D = f(V_{GS}); |V_{DS}| > 2|I_D|R_{DS(on)max}$

parameter:  $T_j$

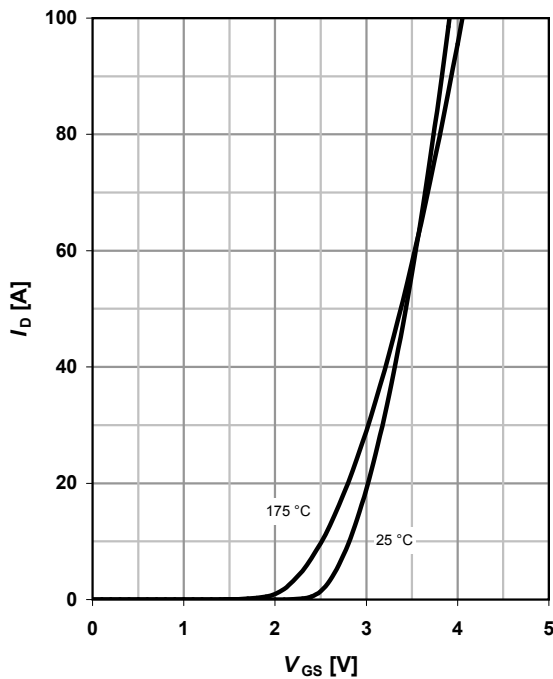

**8 Typ. forward transconductance**

$g_{fs} = f(I_D); T_j = 25\text{ }^\circ\text{C}$

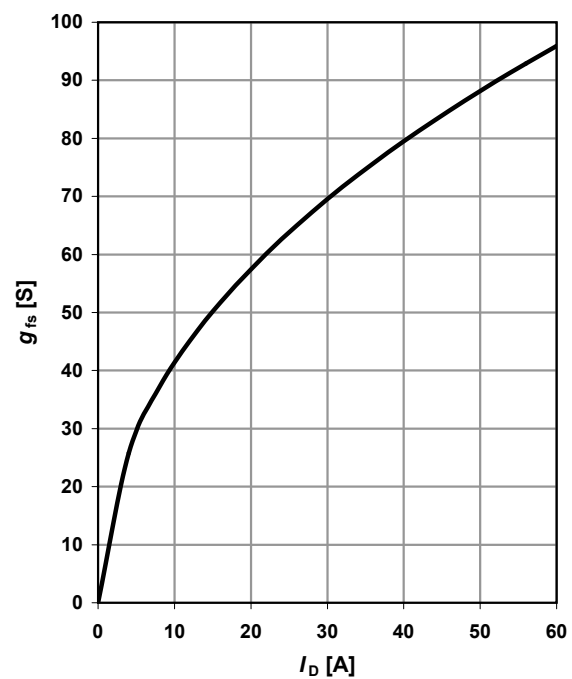

**9 Drain-source on-state resistance**

$$R_{DS(on)} = f(T_j); I_D = 60 \text{ A}; V_{GS} = 10 \text{ V}$$

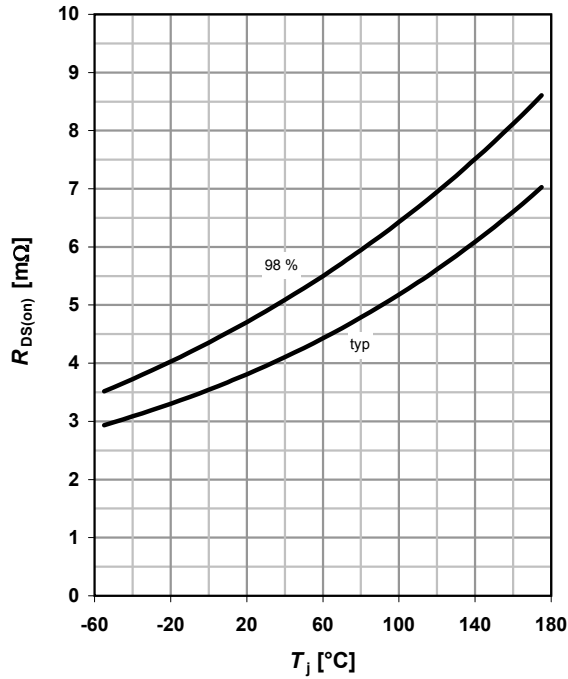

**10 Typ. gate threshold voltage**

$$V_{GS(th)} = f(T_j); V_{GS} = V_{DS}$$

parameter:  $I_D$

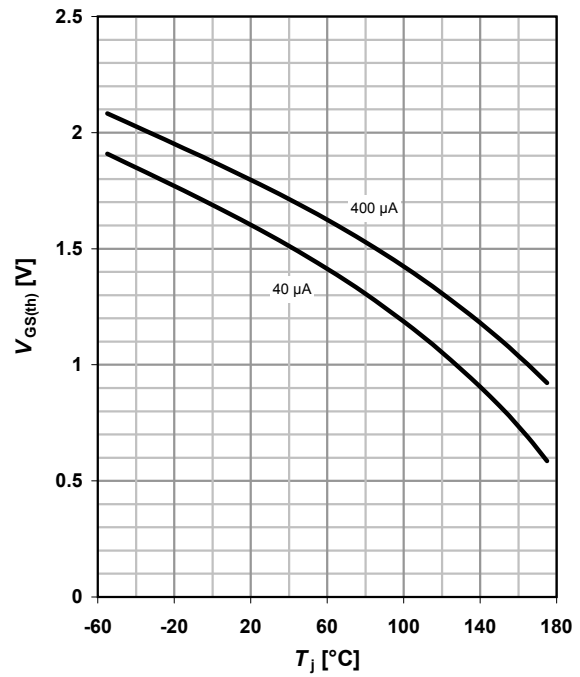

**11 Typ. capacitances**

$$C = f(V_{DS}); V_{GS} = 0 \text{ V}; f = 1 \text{ MHz}$$

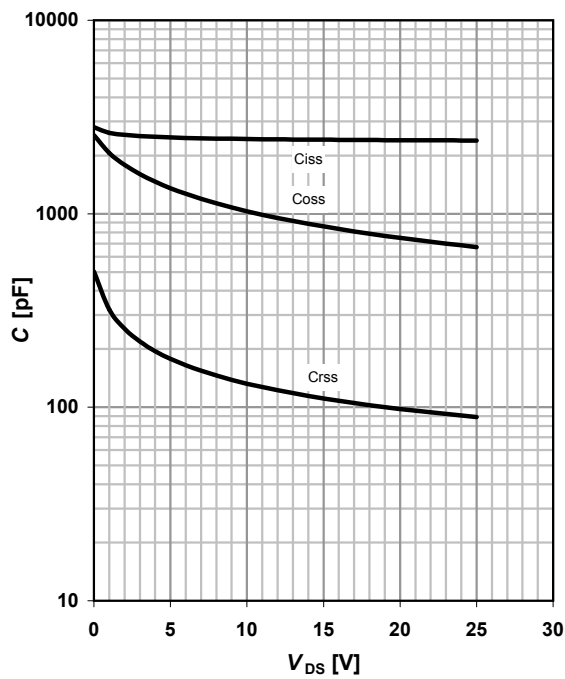

**12 Forward characteristics of reverse diode**

$$I_F = f(V_{SD})$$

parameter:  $T_j$

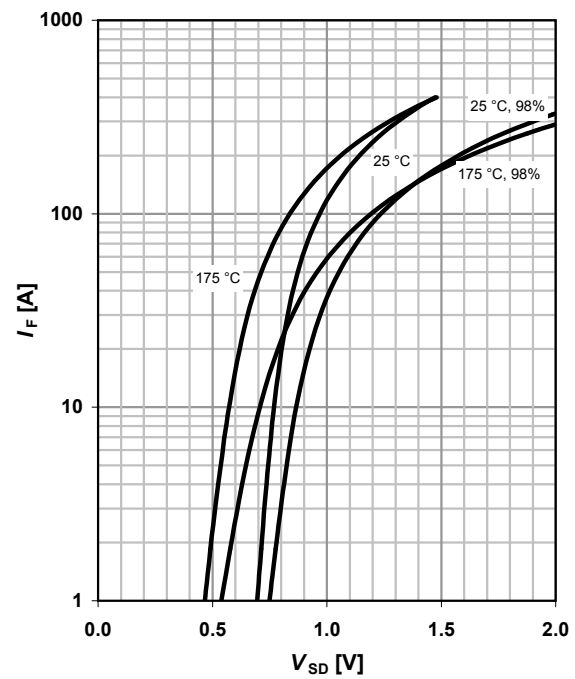

**13 Avalanche characteristics**

$I_{AS}=f(t_{AV}); R_{GS}=25 \Omega$

parameter:  $T_{j(start)}$

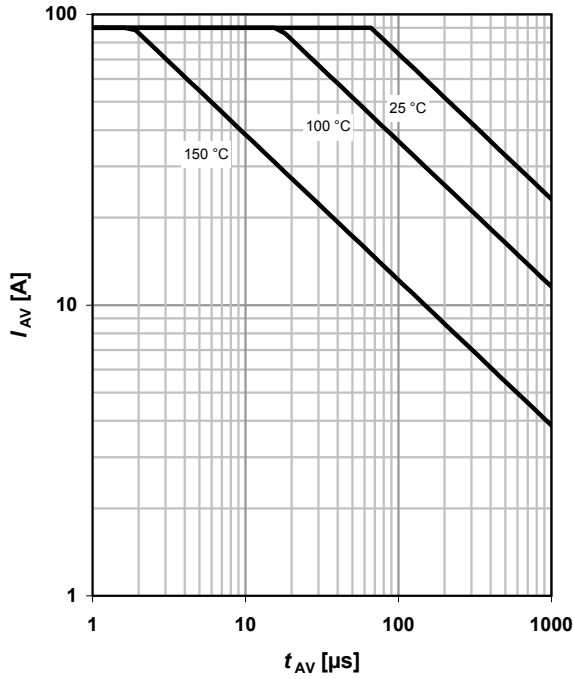

**14 Typ. gate charge**

$V_{GS}=f(Q_{gate}); I_D=45 \text{ A pulsed}$

parameter:  $V_{DD}$

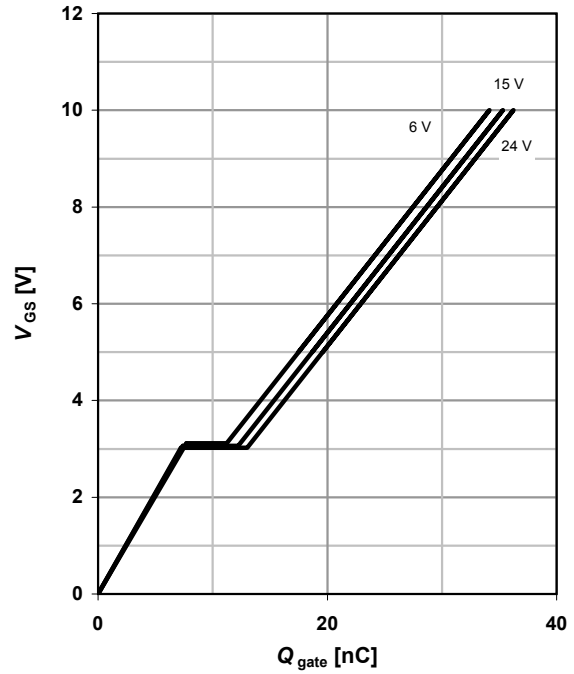

**15 Drain-source breakdown voltage**

$V_{BR(DSS)}=f(T_j); I_D=1 \text{ mA}$

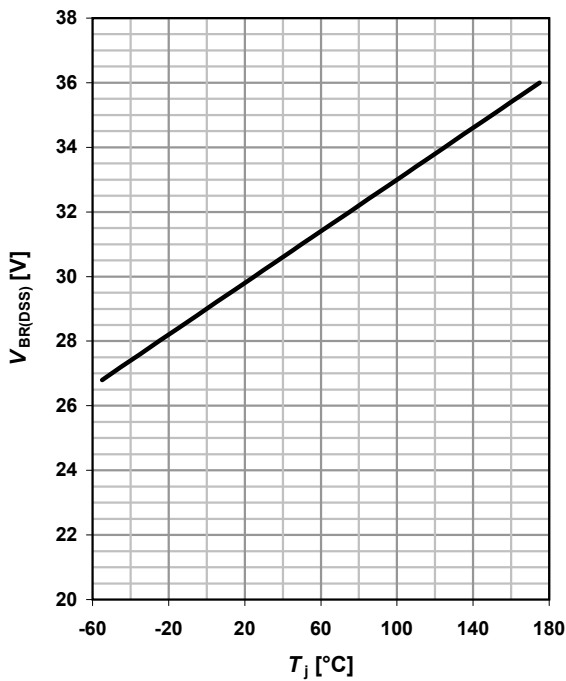

**16 Gate charge waveforms**



Package Outline

PG-TO252-3-11

PG-TO252-3-11: Outline

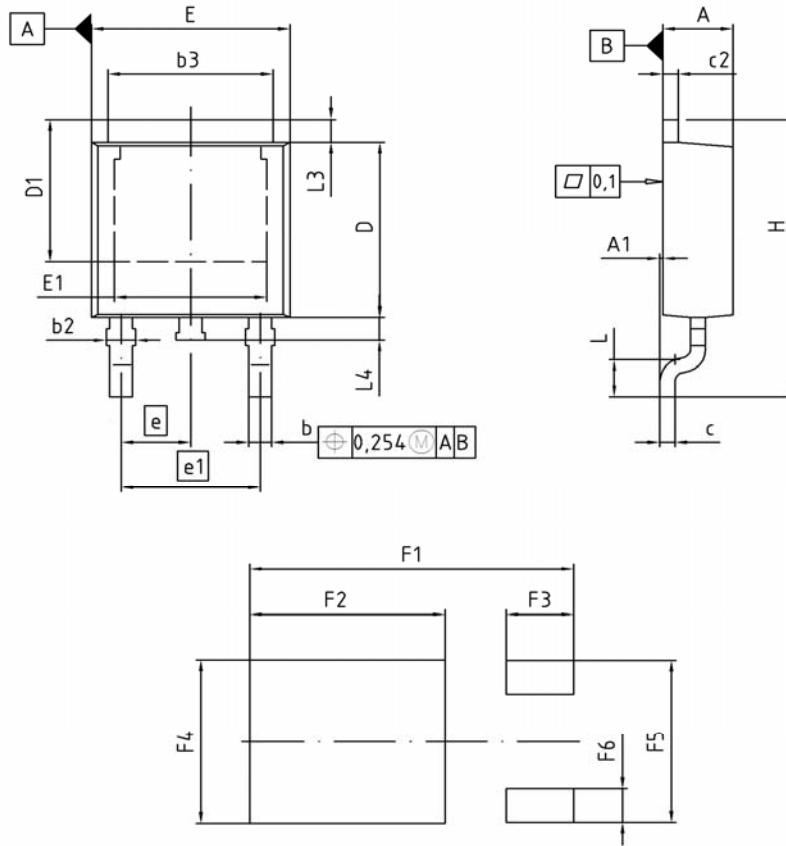

DIM	MILLIMETERS		INCHES	
	MIN	MAX	MIN	MAX
A	2.16	2.41	0.085	0.095
A1	0.00	0.15	0.000	0.006
b	0.64	0.89	0.025	0.035
b2	0.65	1.15	0.026	0.045
b3	5.00	5.50	0.197	0.217
c	0.46	0.60	0.018	0.024
c2	0.46	0.98	0.018	0.039
D	5.97	6.22	0.235	0.245
D1	5.02	5.84	0.198	0.230
E	6.40	6.73	0.252	0.265
E1	4.70	5.21	0.185	0.205
e	2.29		0.090	
e1	4.57		0.180	
N	3		3	
H	9.40	10.48	0.370	0.413
L	1.18	1.70	0.046	0.067
L3	0.90	1.25	0.035	0.049
L4	0.51	1.00	0.020	0.039
F1	10.50	10.70	0.413	0.421
F2	6.30	6.50	0.248	0.256
F3	2.10	2.30	0.083	0.091
F4	5.70	5.90	0.224	0.232
F5	5.66	5.86	0.223	0.231
F6	1.10	1.30	0.043	0.051

DOCUMENT NO.  
Z8B00003328

SCALE

EUROPEAN PROJECTION

ISSUE DATE  
19-10-2007

REVISION  
03



Package Outline

PG-TO251-3-11

PG-TO251-3-11: Outline

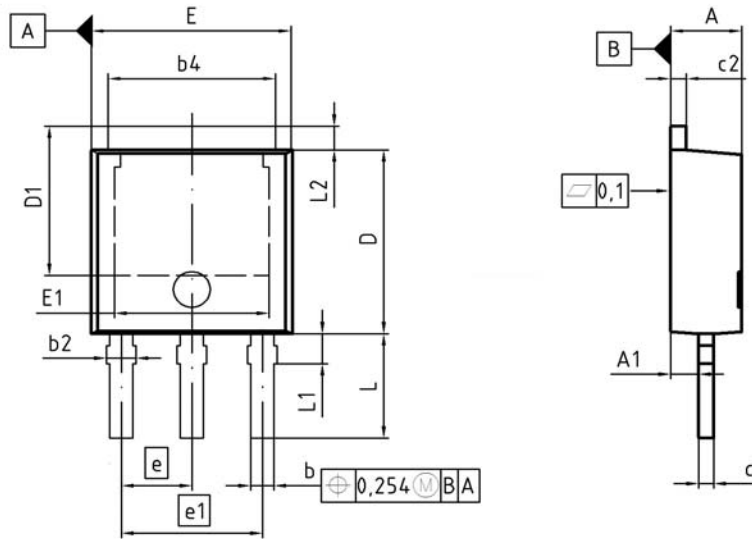

DIM	MILLIMETERS		INCHES	
	MIN	MAX	MIN	MAX
A	2.18	2.39	0.086	0.094
A1	0.80	1.14	0.031	0.045
b	0.64	0.89	0.025	0.035
b2	0.65	1.15	0.026	0.045
b4	4.95	5.50	0.195	0.217
c	0.46	0.58	0.018	0.023
c2	0.46	0.89	0.018	0.035
D	5.97	6.22	0.235	0.245
D1	5.04	5.44	0.198	0.214
E	6.35	6.73	0.250	0.265
E1	4.90	5.10	0.193	0.201
e	2.29		0.090	
e1	4.57		0.180	
N	3		3	
L	3.40	3.60	0.134	0.142
L1	0.90	1.10	0.035	0.043
L2	0.90	1.10	0.035	0.043

DOCUMENT NO.  
Z8B00003329

SCALE

EUROPEAN PROJECTION

ISSUE DATE  
17-01-2008

REVISION  
03

**Published by**  
**Infineon Technologies AG**  
**81726 Munich, Germany**  
**© 2008 Infineon Technologies AG**  
**All Rights Reserved.**

#### **Legal Disclaimer**

The information given in this document shall in no event be regarded as a guarantee of conditions or characteristics. With respect to any examples or hints given herein, any typical values stated herein and/or any information regarding the application of the device, Infineon Technologies hereby disclaims any and all warranties and liabilities of any kind, including without limitation, warranties of non-infringement of intellectual property rights of any third party.

#### **Information**

For further information on technology, delivery terms and conditions and prices, please [contact the nearest Infineon Technologies Office \(www.infineon.com\)](http://www.infineon.com).

#### **Warnings**

Due to technical requirements, components may contain dangerous substances. For information on the types in question, please contact the nearest Infineon Technologies Office.

Infineon Technologies components may be used in life-support devices or systems only with the express written approval of Infineon Technologies, if a failure of such components can reasonably be expected to cause the failure of that life-support device or system or to affect the safety or effectiveness of that device or system. Life support devices or systems are intended to be implanted in the human body or to support and/or maintain and sustain and/or protect human life. If they fail, it is reasonable to assume that the health of the user or other persons may be endangered.